



# IMPORTANT!

Be sure to install the MD15 Valve Actuator  
**PRIOR TO INSERTING BATTERIES & PAIRING**  
the device!

---

## Application

Small radio controlled, battery-powered actuator for room temperature control. For thermostat valve bodies for direct mounting on commercially available radiator valves for room-specific temperature control in heating systems.

The actuator is radio controlled based on the non-proprietary EnOcean radio protocol. The following EnOcean Equipment Profile (EEP) is supported: EEP A5-20-01 Battery Powered Actuator

---

## Safety Instructions

This data sheet contains information on installing and commissioning the product M9-MD15. Each person who carries out work on this product must have read and understood this data sheet. If you have any questions that are not resolved by this data sheet, you can obtain further information from the supplier or manufacturer.

If the product is not used in accordance with this data sheet, the protection provided will be impaired. Applicable regulations must be observed when installing and using the device. Within the EU, these include regulations regarding occupational safety and accident prevention as well as those from the VDE (Association for Electrical, Electronic & Information Technologies). If the device is used in other countries, it is the responsibility of the system installer or operator to comply with local regulations.

Mounting, installation and commissioning work on the devices may only be carried out by qualified technicians. Qualified technicians are persons who are familiar with the described product and who can assess given tasks and recognize possible dangers due to technical training, knowledge and experience as well as knowledge of the appropriate regulations.

# M9-MD15

## Intelligent Valve Actuator Installation



### Technical Specifications

Part Numbers (Frequency Dependant)	M9-MD15 (902 MHz - North America) M8-MD15 (868 MHz - Europe and China) MJ-MD15 (928 MHz - Japan)
Nominal Voltage	Battery-Operated, 3 alkaline AA batteries (LR6AD Panasonic Powerline 1.5 V)
Battery Life	Depends on the frequency and method of operation - approx. 3 years with default settings
Measuring System	Integrated digital temperature sensor; 0..40 °C; ±0.5 °C at 25 °C
Interfaces	EnOcean® radio interface: - Radio telegram: EnOcean radio telegram, bidirectional - EEP A5-20-01 (Battery Powered Actuator) - Frequency: 868.3 MHz - Range: approx. 30 m in buildings (depending on building structure) - Duty cycle: < 1 % - Transmission/reception interval: every 2..20 min, can be set in 2 min increments
Motor Switch-Off	Actuator spindle: when extending = load-dependent, when retracting = path-dependent
Display	Multicolored status LED
Actuating Noise	< 28 dB (A)
Nominal Stroke	Up to 3 mm
Travel Time	10 s/mm
Positioning Force	100 N (nominal)
Position Indication	Stroke range scale
Housing	RAL 9010 pure white, battery compartment cover with mechanical locking mechanism
Ambient temp.	0..50°C
Degree of Protection	IP40
Installation Position	Anywhere from vertical to horizontal
Maintenance	Maintenance-free
Weight	157 g (without batteries); 225 g (with batteries)

- When used properly, this device complies with the requirements of the R&TTE Directive (1999/5/EC).

### Dimensions

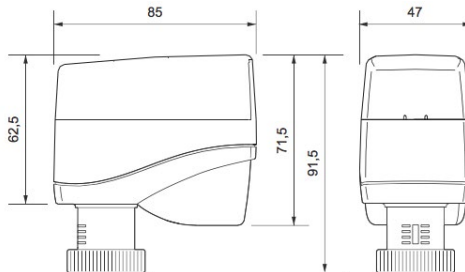

# M9-MD15

## Intelligent Valve Actuator Installation



---

### Radio Small Actuator Functions

#### Actuator mode

If a 0 to 100% EnOcean telegram is received from an external radio partner for controlling the radio small actuator, the internal loop controller is not active. The transmitted actuating signal is translated into a positioning movement. A suitable radio single room controller takes over the control functions.

#### Self-controlling operation

The integrated room temperature controller is activated if no external 0 to 100% EnOcean radio telegram is received.

#### Without external operator panel (= emergency mode):

The temperature is controlled to a fixed setpoint of 20 °C using the integrated temperature sensor (actual value) and the integrated control function of the actuator.

#### With external operator panel (EnOcean technology):

Using the operator panel, the users can freely determine the setpoint or enter their own schedule. The actual value and the setpoint are transmitted via an EnOcean telegram (EEP A5-20-01). The integrated control algorithm makes room control easy and convenient.

#### Battery monitoring

The battery capacity is continuously monitored. If the battery capacity is too low, a radio signal is transmitted to the radio partner and 2 acoustic signal tones are emitted in succession every 6 hours. If this message is activated, the remaining capacity of the batteries is < 10%.

---

### Radio Small Actuator Functions (continued)

#### CAUTION:

The batteries must be replaced within the next 30 days.

As the battery level decreases, the interval between the audible signals becomes shorter and the number of signal tones increases to 4 signal tones in succession every 3 hours. If the remaining battery capacity is insufficient to maintain motorized operation, the actuator moves into the safety position of 50%. The radio communication with the radio partner still functions in this operating state.

#### Valve Recognition

During commissioning, the actuator detects the closing point and the total stroke of the valve. After the batteries are changed or after the unit is successfully taught in on a radio partner, this detection process is performed again via the Init.

#### Valve block protection

Block protection prevents the cone from jamming when the valve is inactive for a long time. When block protection is active, the actuator performs a displacement of 50% once every 21 days. If the remaining battery level is < 10% (see "Battery monitoring" section), this function is inactive. This function can be switched on and off.

#### Automatic closing point control

The small actuator continuously monitors the closing point and corrects it if necessary.

#### Communication test

The radio communication path to the radio partner is checked. Performing a communication test has no effect on the transmission/reception interval.

#### Energy block (automatic "Window open" recognition)

When a window is open, the flow of heat energy to the room is interrupted. An open window is signified by a large and rapid temperature drop at the Mx-MD15 small actuator. If such a drop is measured by the internal temperature sensor, the small actuator closes the valve for 30 min. After 30 minutes, the small actuator returns to normal operation and the automatic "Window open" recognition function is active again.

#### Frost protection function

If the temperature at the integrated temperature sensor drops below 6 °C, the small actuator opens the valve until 8 °C is reached.

#### Summer mode

If the status message "Summer mode on" is received from an external radio partner, the small actuator closes the valve. The transmission/reception interval in summer mode is permanently set to 60 minutes.

# M9-MD15

## Intelligent Valve Actuator Installation



### Radio Interface

The communication with the radio partner is cyclical, bidirectional and includes intelligent reception/ transmission management. Upon the first reception of the radio telegram, the radio small actuator automatically adapts its operating mode according to the method of control from the radio partner (actuator mode or self-controlled mode).

#### NOTE:

If the communication with the radio partner is disrupted, the "emergency mode" status bit (self-controlled mode) is set (can be evaluated for service diagnostics). After the malfunction has been rectified (details can be found in the documentation of the radio partner), the radio partner is automatically resynchronized.

#### CAUTION:

This product uses only EnOcean telegrams. When selecting a radio partner, ensure that the radio interface also works with the EnOcean telegram EEP A5-20-01 (Battery Powered Actuator).

### EnOcean Equipment Profiles EEP A5-20-01 (Battery Powered Actuator)

Transmit Mode	Message from the actuator to the controller
DB_3	Current Value value 0...100%, linear n=0...100
DB_2.BIT_7	Service on
DB_2.BIT_6	Energy input enabled (not applicable)
DB_2.BIT_5	Energy Storage > xx% charged (not applicable)
DB_2.BIT_4	Battery capacity > 10%
DB_2.BIT_3	Contact, cover open
DB_2.BIT_2	Failure temperature sensor, out of range
DB_2.BIT_1	Detection, window open
DB_2.BIT_0	Actuator obstructed
DB_1	Temperature 0...40°C, linear n=0...255
DB_0.BIT_7	Not used
DB_0.BIT_6	Not used
DB_0.BIT_5	Not used
DB_0.BIT_4	Not used
DB_0.BIT_3	LRN Bit 0b0 Teach-in telegram 0b1 Data telegram
DB_0.BIT_2	Self-controlled mode 0b0 off 0b1 on
DB_0.BIT_1	Not used
DB_0.BIT_0	Not used

### R10..20D/E/DV/EV Two-Way Valves for MD15-FTL-HE Radio Small Actuator

Receive Mode rx tim = max. 1s	Commands from the controller to the actuator Note: The data transfer from the radio partner to the radio small actuator must be completely finished within a maximum time window of 1s.
DB_3	Valve set point 0...100 %, linear n=0...100 Temperature set point 0...40°C, linear n= 0...255
DB_2	Temperature actual from RCU = 0b0, Room controller-unit ...
DB_1.BIT_7	Run init sequence, only active in service mode
DB_1.BIT_6	Lift set, only active in service mode
DB_1.BIT_5	Valve open, only active in service mode
DB_1.BIT_4	Valve closed, only active in service mode
DB_1.BIT_3	Summer bit, reduction on energy consumption
DB_1.BIT_2	Set point selection DB_3 0b0 set point 0...100% 0b1 temperature set point 0...40°C
DB_1.BIT_1	Set point inverse
DB_1.BIT_0	Select function 0b0 RCU 0b1 Service on

# M9-MD15

## Intelligent Valve Actuator Installation



### Types:

PN10 gunmetal two-way valve for the small actuator (water up to 120°C)

	Type	DN	PN	Kvs	R
Straight throughput	R10D	10	10	1.25	3/8"
	R15D	15	10	1.35	1/2"
	R20D	20	10	2.5	3/4"
Right-angled throughput	R10E	10	10	1.25	3/8"
	R15E	15	10	1.35	1/2"
	R20E	20	10	2.5	3/4"
Straight throughput with Kvs setting	R10DV	10	10	0.73	3/8"
	R15DV	15	10	0.73	1/2"
	R20DV	20	10	0.73	3/4"
Right-angled throughput with Kvs setting	R10EV	10	10	0.73	3/8"
	R15EV	15	10	0.73	1/2"
	R20EV	20	10	0.73	3/4"

### R10..20D/E/DV/EV Two-Way Valves for MD15-FTL-HE Radio Small Actuator (continued)

#### Technical Data - R10..20D/E/DV/EV Valves

Nominal Diameter	DN10 - 20
Pressure Rating	PN10
Connection	Pipe screw connections in accordance with DIN EN 2115
Actuating Stroke	2 mm
Temperature of Medium	Water up to 120°C
Housing	Gunmetal; nickel-plated
Cone	EPDM
Valve Spindle	Stainless steel
Spindle Seal	EPDM
Maintenance	Maintenance-free

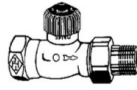

R10..20D, R10..20DV

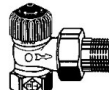

R10..20E, R10..20EV

### Dimensions

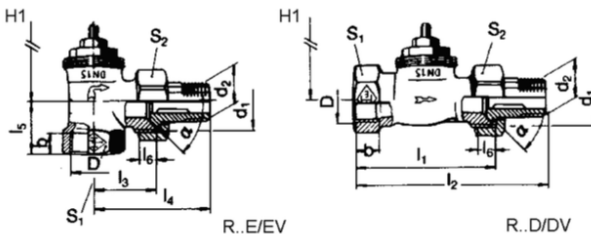

# M9-MD15

## Intelligent Valve Actuator Installation



### Kvs default setting R10 - 20DV/EV valves

To adjust to the heat requirement, the R10 - 20DV/EV valves have 8 flow settings for the radiator mass flow rate.

The maximum flow rate, Kvs value (m<sup>3</sup>/h) can be selected by using the settings 1, 2, 3, 4, 5, 6, 7 or 8 (delivery setting = 8, corresponds to a Kvs value = 0.86).

The setting can be made using a Z29 socket key (accessory). The setting between 1 and 8 can be read from the valve, and will be implemented by the installed small actuator.

Position	1	2	3	4	5	6	7	8
Kvs Value	0,049	0,102	0,185	0,313	0,420	0,565	0,740	0,860

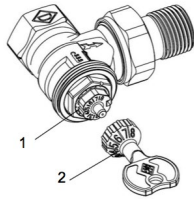

- (1) Setting marks
- (2) Z29 socket key (accessory)

### Valve Installation

#### CAUTION

The valve may only be installed by qualified technicians. In addition to the generally valid installation guidelines, the following points are to be observed:

- The pipeline system and the interior of the fitting must be free of foreign objects. In the event of contaminated media, dirt collectors are to be inserted upstream of the valves with fine screens, mesh width 0.25 mm.
- There must be no tension between the valve and the pipeline connection.
- To avoid eddy formations in the valve body, the valve should be installed in a straight section of the pipe. A distance of 10 times the nominal diameter is recommended between the valve flange and manifold or other similar parts.
- The installation location is to be selected so that the ambient temperature at the actuator is kept between 0 – +50 °C.
- When carrying out installation, the permissible maximum pressure difference  $\Delta p$  and the specified direction of flow must be observed (see table in "Types" section).
- Once the valve is installed, make sure the ball in the valve seating can be moved easily by pushing in the valve stem.
- Approximately 30 mm of free space is required above the actuator to install the actuator and remove the housing cover.
- For safety reasons, do not suspend the small actuators from under the valve.
- Observe the direction of flow arrow on the valve body. Inverting the direction of flow impairs control behavior.

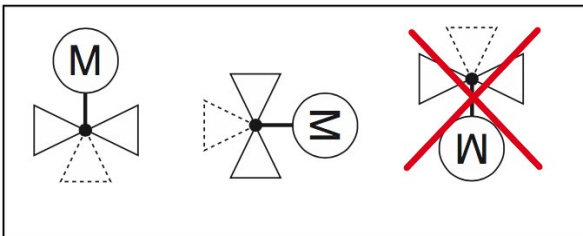

# M9-MD15

## Intelligent Valve Actuator Installation



### Valve Installation (continued)

#### Installing the Radio Small Actuator

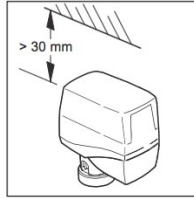
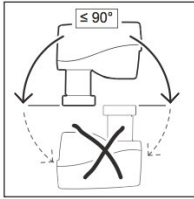

#### CAUTION

Insert the batteries with the correct polarity.

When inserting the batteries, observe the polarity as marked in the battery compartment. Use only alkaline batteries (type: AA, LR6 1.5 V)

#### -MD15-FTL-HE, MD15-FTL-OV

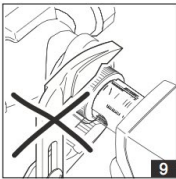
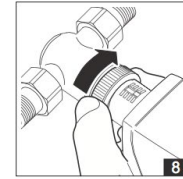
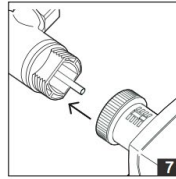
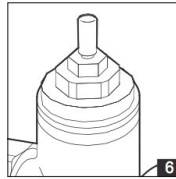
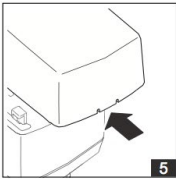
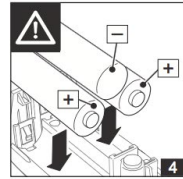
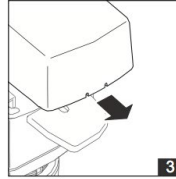
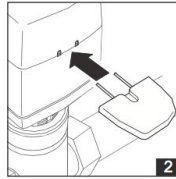
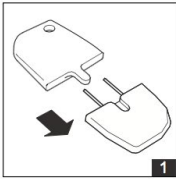

### Valve Installation (continued)

- Open the battery compartment cover using the special key supplied by inserting it into the intended place. Remove the cover. The special key is included with delivery of the small actuator.
- Inserting the batteries and close the battery compartment cover.
- Place the small actuator on the threaded connection of the valve and tighten hand-tight using the union nut.

# M9-MD15

## Intelligent Valve Actuator Installation



### Installing Accessories Z800 to Z816

Z802..Z805

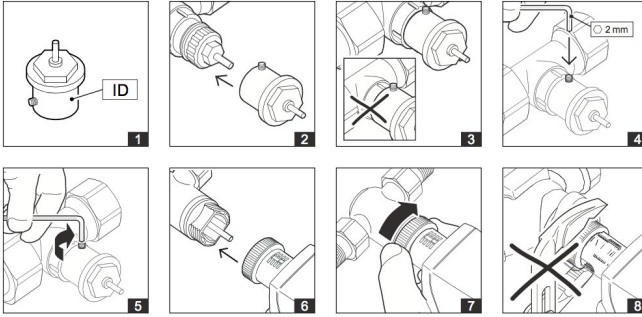

Z800..Z801 and Z806..816

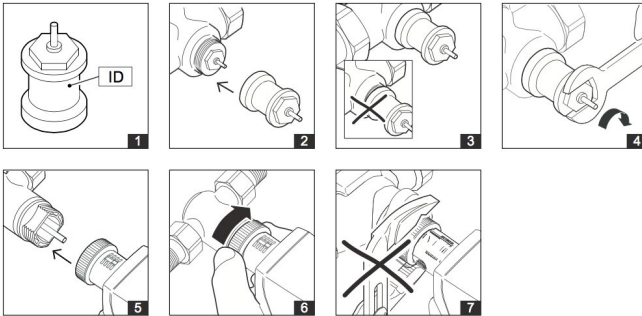

### Installing Accessories Z800 to Z816 (continued)

**CAUTION:**

Before beginning to remove the unit, make sure that no differential pressure builds up in the valve body before beginning work. If necessary, close the gate valve and turn off pumps. After the pipeline has cooled off, you can begin removal of the small actuator.

-MD15-FTL-HE, MD15-FTL-OV

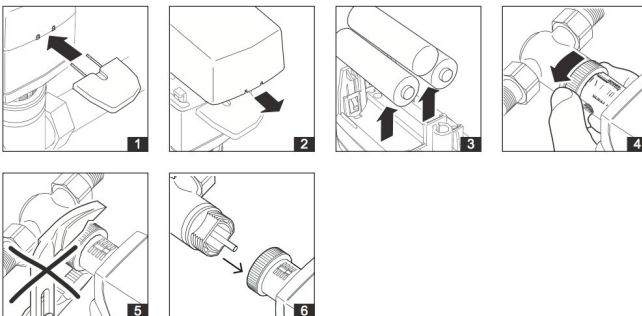



# M9-MD15

## Intelligent Valve Actuator Installation



- Open the battery compartment cover using the special key supplied by inserting it into the intended place. Remove the cover. The special key is included with delivery of the small actuator.
- Remove the battery.
- Loosen the union nut.
- Remove the small actuator from the valve.

### Commissioning

-Overview of functions

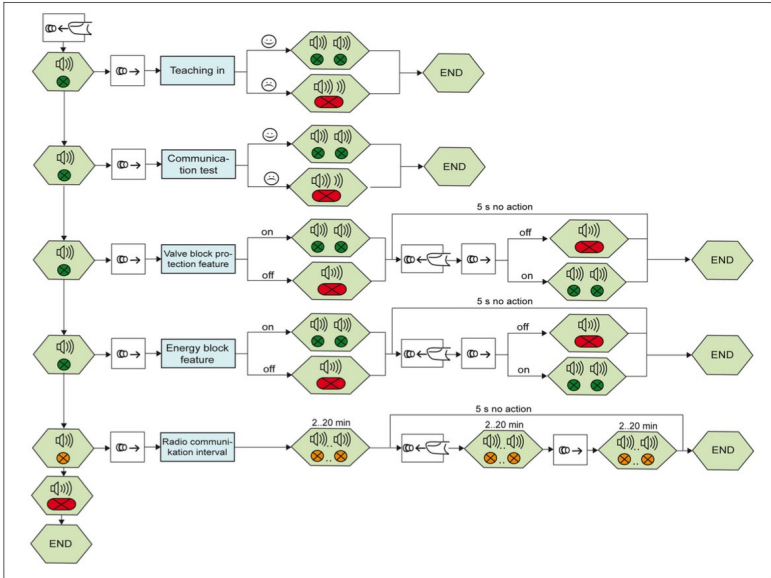

### Commissioning (continued)

#### CAUTION

This product description describes specific settings and functions of the M9-MD15. In addition to these instructions, the product descriptions of other system components, such as radio partners, are to be observed.

- The buttons and LED displays that are used during commissioning are located inside the housing.
- Remove the housing cover before commissioning.

# M9-MD15

## Intelligent Valve Actuator Installation

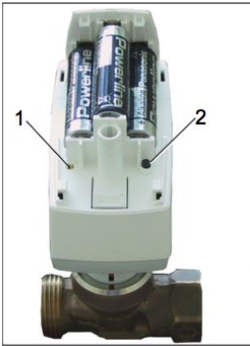
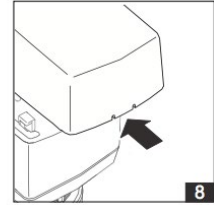
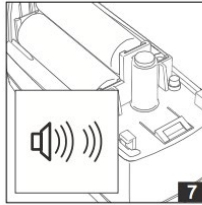
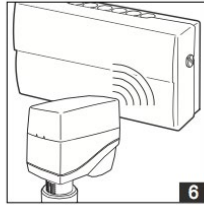
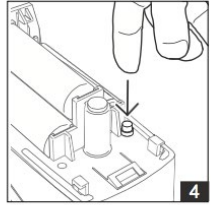
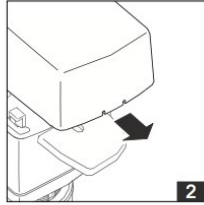
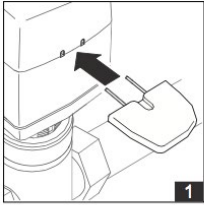

- (1) Status LED
- (2) Push-button

# M9-MD15

## Intelligent Valve Actuator Installation



### Teaching In the Radio Small Actuator on a Radio Partner

---

- Set the radio partner to teach-in standby mode. Details are described in the documentation of the radio partner.
- To trigger a teach-in telegram on the M9-MD15, press the push-button (2) on the M9-MD15 until a signal tone is heard and the status LED (1) lights up green (.
- Release the push-button (2).

The teach-in process is started.

The radio partner confirms that the teach-in process was successful.

Details are described in the documentation of the radio partner.

The radio small actuator confirms that the teach-in process was successful both visually (status LED flashes green 2 times) and acoustically (2 signal tones in succession).

An initialization run is automatically carried out.

- Close the housing of the MD15-FTL-xx by snapping on the housing cover.

#### NOTE

After the teach-in procedure has been successfully completed, the device ID of the radio partner is permanently stored in the radio small actuator. You do not need to perform the teach-in procedure again if you change the batteries.

#### NOTE

If the teach-in process was not successful, this is indicated visually (status LED flashes red for approx. 1 s) and acoustically (downward sequence of tones). Start the teach-in process again.

#### Deleting the Radio Partner

It is not possible to delete the device ID of the radio partner which is saved internally on the M9-MD15. This ID is overwritten by the new radio ID when a new teach-in process is performed.

#### Performing a Communication Test

- Press the push-button (2) and hold it until you hear 2 successive signal tones and the status LED flashes green 2 times.
- Release the push-button.

After the push-button (2) is released, the radio communication path to the radio partner is checked.

A successful communication test is indicated both visually (status LED flashes green 2 times) and acoustically (2 signal tones in succession).

#### NOTE

A successful communication test may require an adjustment of the current valve position.

If the communication test was not successful, this is indicated visually (status LED flashes red for approx. 1 s) and acoustically (downward sequence of tones). The radio small actuator switches to emergency mode.

#### NOTE

In case of an unsuccessful communication test, check the radio partner and the transmission path.

### Teaching In the Radio Small Actuator on a Radio Partner (continued)

---

#### NOTE

If the communication with the radio partner is interrupted for longer than 1 h, the radio small actuator switches to emergency mode (see page 5) and the "emergency mode" status bit (self-controlled mode) is activated. When a correct telegram is received, the radio small actuator automatically returns to normal operation.

#### Switching the Valve Block Protection Feature On and Off

- Press the push-button (2) and hold it until you hear 3 successive signal tones and the status LED flashes green 3 times.
- Release the push-button.

After the push-button (2) is released, the current status (on or off) is indicated visually and acoustically.

-Valve block protection feature on: Status LED flashes green 2 times and 2 signal tones are emitted

- Valve block protection feature off: Status LED flashes red for approx. 1 s and a long signal tone is emitted

- To change the status, you must again press and release the push-button (2) within the next 5 s. The new function setting, either "valve block protection feature on" or "valve block protection feature off," is indicated visually and acoustically as described above.

# M9-MD15

## Intelligent Valve Actuator Installation



Factory setting: On

### Setting the Radio Communication Interval

The transmission/reception interval can be set in 2 min increments, from 2 min to 20 min.

- Press the push-button (2) and hold it until you hear 5 successive signal tones and the status LED flashes green 4 times and orange 1 time.
- Release the push-button (2).

After the push-button (2) is released, the current radio communication interval is indicated visually and acoustically; see Table below "Radio communication interval".

- To change the radio communication interval, you must press the push-button (2) again within the next 5 s and release it once the desired radio communication interval is reached.

This is indicated visually and acoustically; see Table below.

- Release the push-button (2).

The new radio communication interval is acknowledged again both visually and acoustically;

**Default setting:** Transmission and reception interval: 10 min

Radio Communication Interval	Signal
2 min	Status LED flashes 1 time and 1 signal tone is emitted
4 min	Status LED flashes 2 times and 2 signal tones are emitted
:	:
20 min	Status LED flashes 10 times and 10 signal tones are emitted.

### NOTE

If you press and hold the push-button (2) until 6 successive signal tones are heard and the status LED flashes 6 times, the status LED lights up red and a long signal tone (approx. 1 s) is emitted to indicate the end of the setting procedure.

### Replacing Batteries

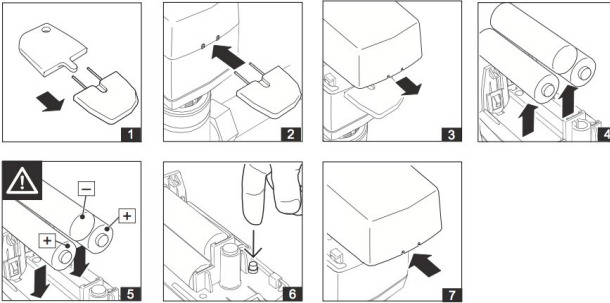

- Open the battery compartment cover using the special key by inserting it into the intended place. Remove the cover.

The special key is included with delivery of the small actuator.

- Remove the batteries.
- Insert batteries and briefly press the push-button.
- Close the battery compartment cover.

### CAUTION

Insert the batteries with the correct polarity.

When inserting the batteries, observe the polarity as marked in the battery compartment. Use only alkaline batteries (type:AA, LR6 1.5 V).

### NOTE

After changing the batteries, the radio small actuator goes into storage mode (actuator spindle is retracted). When the actuator receives a radio signal, it switches over to normal operation.

### CAUTION

If the battery is changed on the disassembled radio actuator, the radio actuator remains operational. Assembly can only be performed on the valve if no positioning movements are being carried out on the radio actuator.

### NOTE

#### Disposing of batteries in an environmentally friendly manner

Batteries are marked with this symbol. This symbol indicates that it is prohibited to dispose of batteries in the household waste. Dispose of used batteries at an approved collection point or store in accordance with legal regulations, or follow the applicable guidelines in your country for reducing harmful waste caused by batteries.