

# Occupancy Sensor- Ceiling Mounted [M9-EOSC]

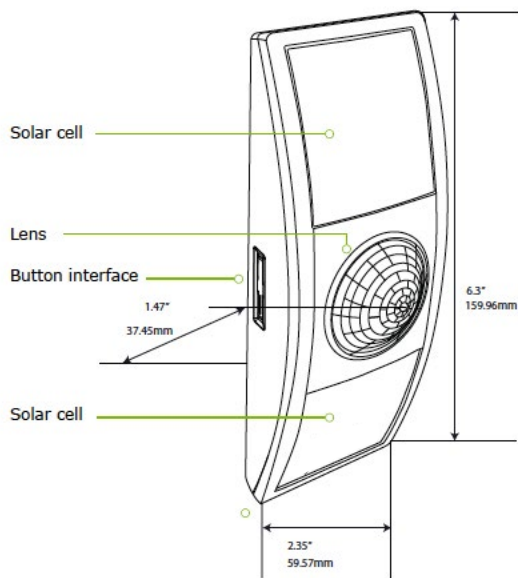

#### Package Contents:

- Occupancy Sensor.
- 2 screws, 2 wall anchors.
- Wire bracket.

#### Tools Required:

- Power drill, 3/16" bit.
- Screwdriver.
- Light meter.
- Battery (CR2032) for testing.

#### Product Description:

The Magnum ceiling-mounted Occupancy Sensor saves energy and adds convenience by accurately detecting when an area is occupied or vacant.

It is a wireless, solar-powered sensor that detects occupancy using passive infrared (PIR) heat and motion sensing. The sensor transmits RF messages to Magnum lighting, HVAC, and outlets to use energy more efficiently.

#### Features Include:

- Sends wireless messages to other devices whenever motion is detected
- Harvests ambient solar energy to power the sensor and wireless communication
- Mounts easily on any ceiling material
- Works with other sensors for enhanced occupancy tracking
- Built-in tests to confirm operation at installed location
- Supplemental battery option for extreme low-light fail-over



**Proudly Made  
In America**

#### SPECIFICATIONS:

Part Numbers (Frequency Dependant)	M9-EOSC (902 MHz - North America) M8-EOSC (868 MHz - Europe and China) MJ-EOSC (928 MHz - Japan)
Power Supply: Optional:	Indoor light energy harvesting Supplemental battery (CR2032) 2-wire connector for external power or remote solar cell (3-5 VDC)
RF Transmission Range	80 ft. (25 m)
Motion Sensing Range	40 ft. (12 m) diameter (refer to coverage diagrams)
Startup Charge Times* First motion transmission / Linking Motion LED blink Light Test / Walk Test	(operation from empty energy storage) 5 minutes @ 200 lux  1.5 hours @ 2000 lux
Sustaining Charge Time for battery free operation	3 hours per 24 hours @ 200 lux
Time to Full Charge*	25 hours @ 200 lux
Operating Life in Total Darkness	80 hours (after full charge)
Minimum Operating Light	50 lux (for auto-off only)
Optional Battery Life: • Infrequent Bright Light • Consistent Low Light • Total Darkness	20 yrs (with 200 lux for 2 hrs/day, 7 days/week) 15 yrs (with 65 lux for 5 hrs/day, 7 days/week) 6.5 yrs
Motion Transmission Interval	2 minutes
Unoccupied Transmission	10 and 30 minutes since last motion
Heartbeat Transmission Interval (unoccupied)	Disabled by default Enabled = heartbeat @ 1 hr interval (after unoccupied messages)
EnOcean Equipment Profile	A5-07-01 (EEP)
Dimensions	6.30" L x 2.35" W x 1.47" D (160 mm x 60 mm x 37 mm)
Weight	4.4 oz. (125 g)
Mounting Height	7-10 feet (2-3m) recommended
Environment	Indoor use only 14° to 104°F (-10° to 40°C) 20% to 95% relative humidity (non-condensing)
Agency Compliance	FCC, IC, RoHS, CE, R&TTE

\*Natural bright light (2000 lux) or a battery can be temporarily used to significantly shorten startup charge times. Specified lux values are for a typical fluorescent lighting. Lux level requirements for LED and other types may vary. For lux reference, OSHA standards require a minimum of 323 lux for office areas.

#### PLANNING:

Take a moment to plan for the sensor's successful operation and optimal communication with other system components. Remove the sensor from its packaging and place it in a strong light to provide the required startup charge. (Tip: To quickly ensure the sensor energy storage is fully charged, insert a CR2032 battery for 30 seconds.)

- Ensure the location provides consistent and adequate light
- Locate the sensor in the center of the room with an unobstructed view of the space
- Avoid installed near ceiling fan or hanging fixtures
- Consider the area's traffic patterns and principal use, for example, walking, lounging or sleeping
- Confirm a location is suitable by temporarily mounting the sensor and testing it, see Walk Test and Light Test sections
- Consider the construction materials in the space and obstacles that may interfere with RF signals

# Occupancy Sensor- Ceiling Mounted [M9-EOSC]

## Coverage Diagrams

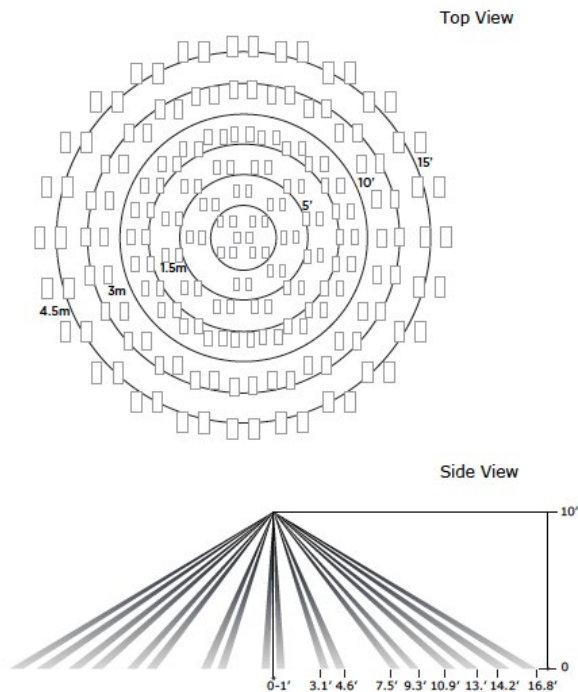

**Tip:** To provide coverage for very high ceilings, a wall sensor can be incorporated in the plan for complete coverage.

## Installing

The occupancy sensor can be mounted on most ceilings with the provided screws, or mounted on dropped ceilings, using the provided wire bracket.

1. Decide where you want to install the occupancy sensor.

Tip: For visual alignment, orient the sensor parallel to one of the walls.

2. Remove the mounting plate from the sensor.

3. Decide which of the two installation options is appropriate.

### Screw Mounting Plate to the Ceiling

a. Hold the mounting plate in place on the ceiling and use a pencil to lightly mark two small dots for the screw drill points.

b. Drill two holes with a 3/16" drill bit and insert the wall anchors.

c. Insert the first screw loosely and level the mounting plate.

d. Insert the second screw and then hand-tighten the first screw.

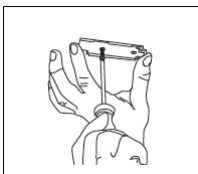

### Mount Using the Wire Bracket

a. Remove the ceiling tile where you want to mount the sensor.

b. Place the mounting plate squarely on the ceiling tile and use the wire to mark two points for the holes.

c. Punch two small holes through the ceiling tile at the marked points.

d. Insert the wire bracket through the two holes in the mounting plate.

Make sure the ends are roughly even.

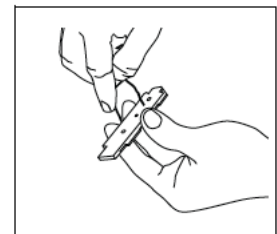

e. Feed the wires through the holes in the ceiling tile.

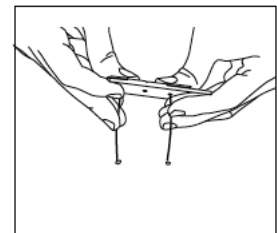

f. On the front of the ceiling tile, flatten the wire bracket so it is snug against the mounting plate.

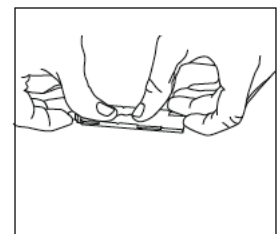

g. On the back of the ceiling tile, twist the wires together to hold the mounting plate securely.

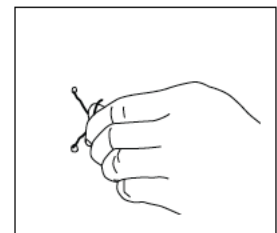

h. Replace the ceiling tile.

# Occupancy Sensor- Ceiling Mounted

## [M9-EOSC]

4. Attach the sensor to the mounting plate.

With the 2-button interface facing you, slide the sensor to the left on the mounting plate until it snaps into place.

Note: It may be easier to link the sensor before it is mounted on the ceiling. See the Linking section.

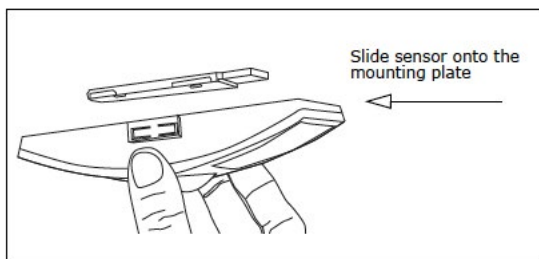

5. Confirm the sensor is properly positioned to detect motion and has sufficient light to operate, see the Walk Test and Light Test sections.

### Linking

Magnum wireless systems are highly flexible; two or more compatible devices can be linked and configured to provide the desired control.

There are two basic types of devices in the Magnum system; transmitters and transceivers.

- Transmitters are simple energy-harvesting devices that send RF messages to communicate a condition, level, or state. Transmitters can only be linked to transceivers.
- Transceivers are wire-powered controlling devices that send as well as receive RF messages. They also process relevant control logic, and actuate the appropriate outputs (switching a light on or off for example). Transceivers can be linked to transmitters as well as other transceivers. A Magnum transceiver can have up to 30 devices linked to it.

#### The Occupancy Sensor is a Transmitter

To link devices, the transceiver must first be powered, within the transmission range, and set to accept links using the 2-button interface on the transceiver.

Next, the desired transmitter, or another transceiver, is triggered to send a special link message. The awaiting transceiver receives and stores the link permanently so the devices can interact to provide a variety of intelligent control options.

#### To link the sensor to a transceiver:

Note: If the sensor is the only device linked to the transceiver, Auto-On and Off will be enabled.

1. Set the desired transceiver to Accept a Link.
2. Click the Menu button on the side of the sensor once.

*Note: The button interface on the sensor is used for linking and testing only. The occupancy timer settings are configured on the transceiver to which the sensor is linked.*

*The Set LED on the transceiver displays solid green for 3 seconds, if the link was successfully established.*

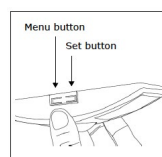

### Testing the Sensor

Before starting a test, ensure the sensor's energy storage is fully charged by placing it in a strong light (200 lux) for 20 minutes or insert the battery for 30 seconds.

If a battery is used to charge the sensor for a light test, ensure it is removed to get an accurate light measurement.

A test mode will stay active for 3 minutes. To exit a test and resume normal operation, press and hold the Menu button for 5 seconds.

### Walk Test

Use the walk test to confirm the sensor's sensitivity to motion within its range.

1. Press and hold the Set button for 5 seconds. The red LED will blink to confirm that a walk test is active.
2. Move in and out of the sensor's range to determine its coverage area. The sensor will blink when it detects motion.
3. Make small hand movements just inside the limit of the sensor's range to see if the motion triggers a response.

### Light Test

Use the light test to measure real-time light levels and confirm whether the occupancy sensor has sufficient light.

1. Create a realistic lighting condition (the test measures the real-time light level).
2. Press and hold the Set button for 10 seconds. The red and green LEDs will blink to confirm that a light test is active.
3. Watch the LED blink rate to determine the light strength. The highest is 5 blinks which indicates very good light (200 lux or more). 1 blink indicates minimum light (15 lux).

Note: If there is no blink rate, consider relocating the sensor or installing a battery to provide supplemental power.

# Occupancy Sensor- Ceiling Mounted

## [M9-EOSC]

### Installing Supplemental Battery (optional)

If light levels are very low where the sensor is installed, auxiliary battery power (CR2032) can be used to supplement the solar energy harvester.

1. Remove the sensor from the mounting plate. With the 2-button interface facing you, slide the sensor to the right.
2. Turn the sensor over and identify the battery holder on the circuit board.

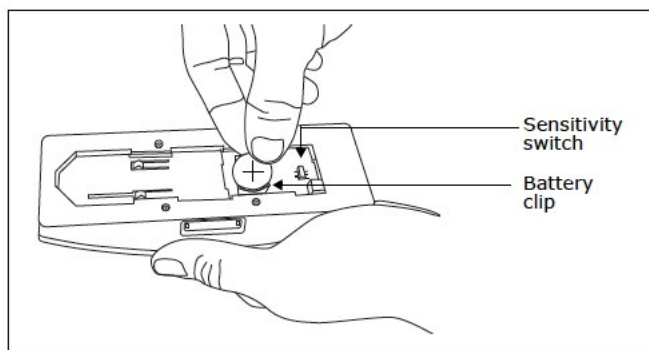

3. Insert the battery under the clip with the positive pole (+) up and press it in place.
4. Remount the sensor on the mounting plate.

### Trouble Shooting

The sensor does not generate a wireless message.	<ul style="list-style-type: none"> <li>• Verify the LED blinks when motion is detected.</li> <li>• Verify the solar cell is charged properly.</li> </ul>
The sensor is activated when there is nothing to detect.	<ul style="list-style-type: none"> <li>• Verify there is 4ft. clearance from heat sources that may disturb sensing.</li> <li>• Reduce the sensitivity setting by moving the switch on the back of the sensor to the left-hand position.</li> </ul>
The linked device does not respond to wireless messages.	<ul style="list-style-type: none"> <li>• Check for the environment range issues</li> <li>• Verify the device is linked.</li> <li>• Check the transceiver connection and the wiring for errors.</li> <li>• Check if appropriate devices are linked according to good system planning.</li> </ul>

FCC SZV-STM900C  
I.C. 5713A-STM300C



This device complies with Part 15 of the FCC Rules. Operation is subject to the following two conditions: (1) this device may not cause harmful interference, and (2) this device must accept any interference received, including interference that may cause undesired operation.