

Proudly Made In America

Mx-OPUS-HBKOD

FIXTURE INTEGRATED LIGHTING CONTROL



OVERVIEW:

Magnum’s fixture integrated Mx-OPUS-HBKOD node enables any lighting manufacturer with a high bay lighting offering to deliver simple, fully connected fixtures. The form factor includes a digital PIR and ambient light sensing for daylight harvesting applications as well as very accurate occupancy detection. Easy to integrate into a high bay fixture through an available half inch knock out, OPUS node bi-directionally communicates data to and from the lighting control network. When connected to a Philips Advance Xitanium SR LED driver or OSRAM Dexas driver, the Mx-OPUS-HBKOD is able to be powered from the driver and can extract critical data from the driver, including power reading.

DESCRIPTION:

The Mx-OPUS-HBKOD is designed to fit into most high bay LED lighting fixtures. The digital PIR sensor is rated for ceilings up to 39 feet. Although configurable for advanced settings, the Mx-OPUS-HBKOD is designed for plug and play applications. It is flexible enough for both localized control as well as software driven enhancement and also integration for BACnet through Magnum’s eBox (Mx-EBOX). The critical data points provided from this node includes occupancy status, light levels, light status and power reading.

THREAD PLACEMENT PART NUMBERS:

<p>Mx-OPUS-HBKOD-SS ("x" = Frequency Dependant)</p>	<p>M9 - (902 MHz - North America) M8 - (868 MHz - Europe & China) MJ- (928MHz - Japan)</p>	
<p>Mx-OPUS-HBKOD-LS ("x" = Frequency Dependant)</p>	<p>M9 - (902 MHz - North America) M8 - (868 MHz - Europe & China) MJ- (928MHz - Japan)</p>	
<p>Mx-OPUS-HBKOD-BS ("x" = Frequency Dependant)</p>	<p>M9 - (902 MHz - North America) M8 - (868 MHz - Europe & China) MJ- (928MHz - Japan)</p>	



Proudly Made
In America

Mx-OPUS-HBKOD

FIXTURE INTEGRATED LIGHTING CONTROL

FEATURES:

- Full digital passive infrared
- Light Level
- Wireless communication
- Daylight harvesting
- Zone control allows multiple fixtures to share data
- Energy reporting at fixture level
- Remotely configurable
- Powered from Xitanium SR, OSRAM Dexal or DALI power supply

TECHNICAL DATA:

Motion Sensing	Digital Passive IR
Detection Distance	12 m (39.3696 ft)
Detection Range (Horizontal x Vertical)	102° x 92°
Detection Zone	92 Zones
Ambient Light Sensing	0-94.8 FC (0-1020 LUX) Photo IC type
Operating Temperature	32° to 140°F (0° to 60°C)
Minimum Power Requirement	16V @24mA from DALI driver
Standby Power	< 1W
Enclosure	ABS Plastic
Radio Frequency	868 MHz, 902 MHz, 928 MHz
Wireless Protocol	EnOcean Wireless Protocol
Wireless Range	150 ft (50 ft to 150 ft typical)
Certifications	IEC 62386-101:2014 IEC 62386-103:2014 DLC



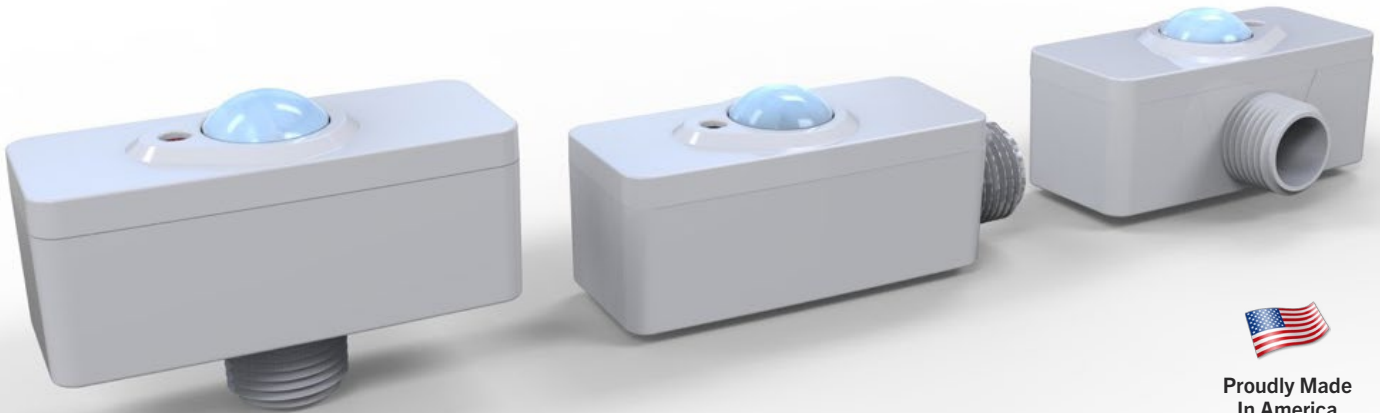

Proudly Made
In America

Mx-OPUS-HBKOD

FIXTURE INTEGRATED LIGHTING CONTROL

DETECTION PERFORMANCE:

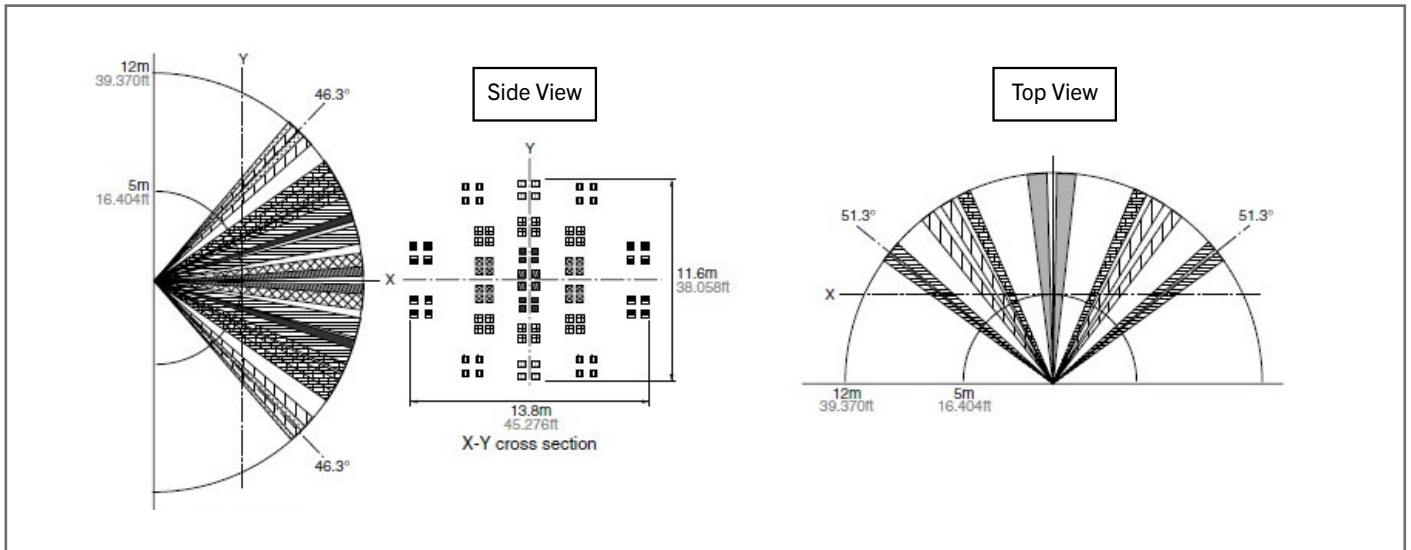

DIMENSIONS:

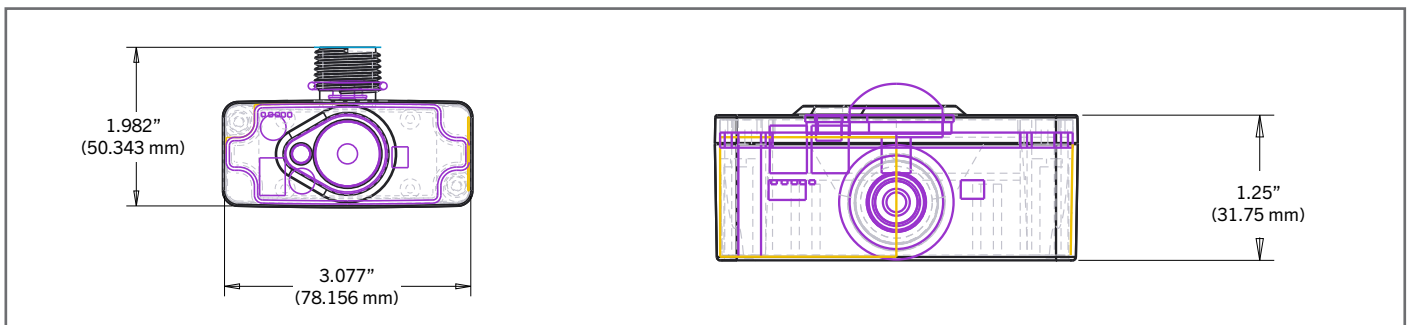

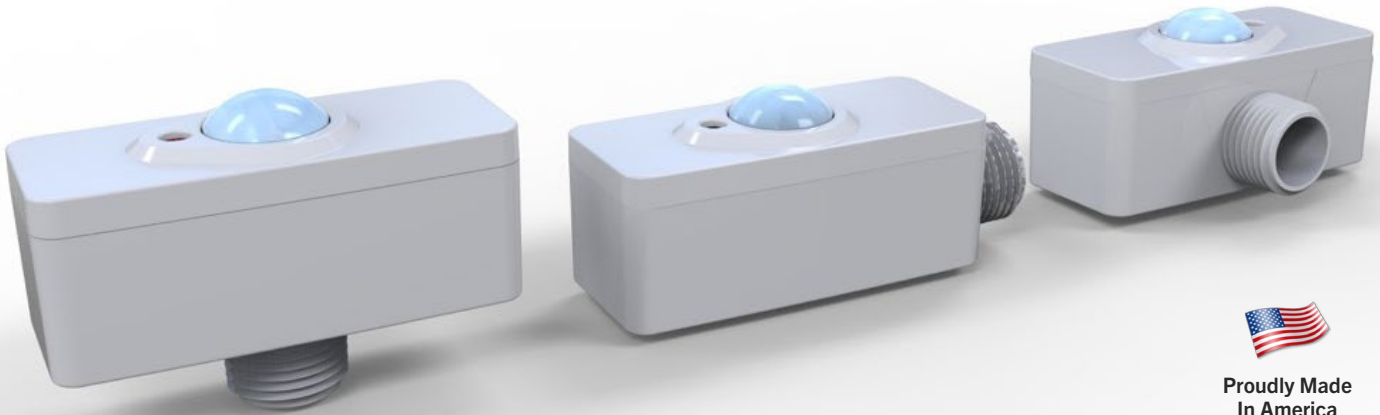

Mx-OPUS-HBKOD

FIXTURE INTEGRATED LIGHTING CONTROL

WIRING DIAGRAM:

